

# CONTENT

News .....	p. 2-3
Flat Screen Arms .....	p. 4-14
Plasma-/LCD-attachments.....	p. 5, 14
Recycling station.....	p. 15
Cable Handling/Cable Grommets .....	p. 16-18
CPU Holders.....	p. 19-21
Computer Security .....	p. 22-23
Integrated Electrics and Computer Products .....	p. 24-27 (Power Box / Powercenter / Powerport)
Ergonomical Products above Desk.....	p. 28-30
Floor Protection/Ergonomic Mats.....	p. 31

---

## General Information

Terms of delivery:	Ex works Dalstorp, Sweden.
Terms of payment:	According to agreement. Excl. packaging. Excl. VAT.
Price adjustments:	We reserve the right to change the prices in this price list with prior notice.
Delivery time:	According to agreement (immediate delivery where possible).
Damages during transport:	If the packaging arrives damaged, please contact the shipping agent directly.
Special colour:	Ask for quotation.
Claims:	Any claims should be made to Götessons within 7 days from reception of goods. Götessons shall approve returns in advance.  Returns due to mistakes in the order caused by customer will only be credited by 80% of the value of the product. The product should be returned in the original packaging and in perfect condition. Freight costs will be paid by the customer.
Guarantee:	2 years.

---



## QUALITY ISO 9001:2000 ENVIRONMENT ISO 14001:2004

We are certified since 2003.  
Our policy is to work systematically and continuously with quality and environment friendly. Our aim is to be a serious partner, where our products will be associated with good service, quality and on schedule delivery.

# PRODUCT INDEX A – Z

*Facts are found on the bolded pages.*

Ali CPU holder.....	20
Anyway arm.....	14
Anyway CPU.....	19, 20
Anyway walltracX.....	14
Assembly hook for HalfPipe.....	16
Asymmetrical arm rest + Mouse pad.....	29, 30
Backpack.....	28
BoxUp.....	21
Bubble.....	31
Cable Collector.....	18
Cable Collector Ø 22, Ø 60.....	18
Cable grommet.....	18
Cable grommet Design.....	7, 8, 12, 13
Cable holder for Conference tables.....	17, 27
Cable holder.....	17
CableCare Cable holder.....	17
Circle saw Cable through.....	18
Circle saw Powerport.....	24
Circle saw T-dock.....	25
Client box.....	23
Cobra Cable Collector.....	18
Complete set.....	16
CPU holder 1.....	20
CPU stand with shelf.....	20
CPU trolley.....	20
DockIT.....	19, 21
DockIT Flexible.....	21
Document Holder.....	29
Document rack for Jellyfish.....	28
Evo arm.....	10, 11, 12
Floor Cable Collector.....	18
Floor Protection.....	31
Foot Support.....	31
Free arm.....	10, 11, 13
Free wall.....	11
Fixing Plates.....	23
G-49, G-79 Cable holder.....	17
G-box.....	22
G-clips.....	16
Gel Keyboard.....	29
Gel Mouse.....	29
Junction box.....	16
G-wire.....	23
HalfPipe Cable holder.....	16
Interior Screen for Swingit.....	19
Jellyfish.....	28
Junction Box.....	16, 24, 25, 26, 27
Lapsaver.....	23
Laptop combination lock.....	23
Laptop box.....	22
LED lamp.....	10, 11
Linjé.....	4, 5, 6, 7, 17
Long Reach arm.....	13
MakelTcooler.....	28
MakelTsoft.....	28
Mouse/Keyboard PS/2.....	16
Network Cat 6.....	27
Network connection.....	27
Network switch.....	27
Padlock.....	14, 23
Plasma/LCD - Linjé.....	5
Plastic clip for cables.....	27
Power Box double.....	27
Power Box single.....	26
Powercenter.....	25
Powerport.....	24
Projector holder.....	5
Quick Cable holder.....	17
Recycling station.....	9
RollerMouse.....	30
RollerWave.....	30
Rotation arm.....	9
Runner concept.....	19
Setupit recycling station.....	15
Simple Rest.....	29
Sopi plastic bags.....	15
Sound Cable.....	27
Stand CPU holder.....	19, 20
Swingit CPU holder.....	19
T-Dock.....	25
Toolbar fittings.....	9, 10, 11
Toolbar mount.....	10, 11, 12, 13
VESA plate.....	5, 7
VGA switch/cable RGB.....	16, 27
Volume 47 Cable holder.....	17
WallIT.....	14
Wireless Keyboard.....	6, 30
Wirelock anti-theft.....	23
Wishbone.....	8
Wishbone Toolbar.....	9
Wrist Support.....	29

# PRODUCT INFORMATION

Art.No.	Size/Description	Colour	Price €
---------	------------------	--------	---------

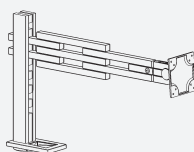

## Linjé Cable grommets Design complete

601655	Mini arm	L. 315 mm	silver	<b>255,00</b>
602655	Short arm	L. 540 mm	silver	<b>289,00</b>
603655	Long arm	L. 670 mm	silver	<b>299,00</b>

Content: Post 400 mm, arm\*, cable grommet Design.

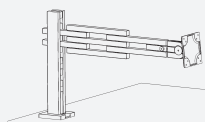

## Linjé Desk mount complete

601650	Mini arm	L. 315 mm	silver	<b>255,00</b>
602650	Short arm	L. 540 mm	silver	<b>289,00</b>
603650	Long arm	L. 670 mm	silver	<b>299,00</b>

Content: Post 400 mm, arm\*, desk mount.

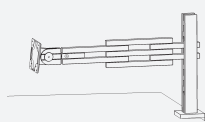

## Linjé Desk clamp complete

601600	Mini arm	L. 315 mm	silver	<b>255,00</b>
602600	Short arm	L. 540 mm	silver	<b>289,00</b>
603600	Long arm	L. 670 mm	silver	<b>299,00</b>

Content: Post 400 mm, arm\*, desk clamp.

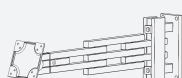

## Linjé Wall mount complete

601630	Mini arm	L. 315 mm	silver	<b>255,00</b>
602630	Short arm	L. 540 mm	silver	<b>289,00</b>
603630	Long arm	L. 670 mm	silver	<b>299,00</b>

Content: Post 200 mm, arm\*, wall mount.



## Linjé Laptop Optimal Desk clamp

606500	DockIT wood, desk clamp, complete		silver	<b>522,00</b>
606505-5	DockIT plexi, desk clamp, complete		chrome	<b>722,00</b>

Content: Post 400 mm, 2 pcs of arms\*(2 x 670 mm), desk clamp, wood or plexiglass shelf. Incl. rubber mat and 2 adjustable stops for the laptop.



## Linjé Laptop Optimal Desk mount

606550	DockIT wood, desk mount, complete		silver	<b>522,00</b>
606555-5	DockIT plexi, desk mount, complete		chrome	<b>722,00</b>

Content: Post 400 mm, 2 arms\*(2 x 670 mm), desk mount, wood or plexiglass shelf. Incl. rubber mat and 2 adjustable stops for the laptop.

\* All arms include VESA attachment standard for both monitor clamp 75 and 100. Max. weight 12 kg.

Posts and arms are made from **solid** homogeneous anodized aluminium. The attachments are casted in aluminium. Most of the products of the Linjé concept are also available in **chrome, black and red**, price supplement 30%. Add following ref. to Art.No: black = "-2", chrome = "-5", red = "-12".

Please look at the possible combinations on page 7.

# PRODUCT INFORMATION

Art.No.	Size/Description	Colour	Price €
---------	------------------	--------	---------

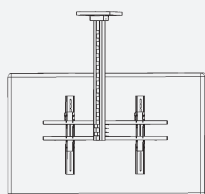

## Linjé Plasma/LCD Ceiling mount

606700		silver	433,00
606700-2		black	563,00
606700-5		chrome	563,00
606700-12		red	563,00

Content: Ceiling mount, post 700 mm, plasma/LCD mount.

Facts: Turnable 90°, tilt angle 15°. Max. weight 50 kg.

Adjustable mounting. W: 80-620 mm. H: 200-400 mm.

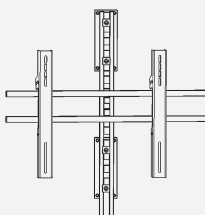

## Linjé Plasma/LCD Wall mount

606730		silver	433,00
606730-2		black	563,00
606730-5		chrome	563,00
606730-12		red	563,00

Content: Wall mount, post 700 mm, plasma/LCD mount.

Facts: Turnable 60°, tilt angle 15°. Max. weight 50 kg.

Adjustable mounting. W: 80-620 mm. H: 200-400 mm.

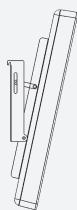

## Plasma wall attachment

610520		silver	109,00
--------	--	--------	--------

Facts: Wall mount, tilt angle 15° for plasma or LCD.

Max. H: 480 mm. Max. W: 800 mm. Max. weight 75 kg.

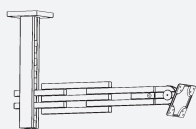

## Linjé Ceiling mount complete

601660	Mini arm	L. 315 mm	silver	255,00
602660	Short arm	L. 540 mm	silver	289,00
603660	Long arm	L. 670 mm	silver	299,00

Content: Post 400 mm, arm\*, ceiling mount.

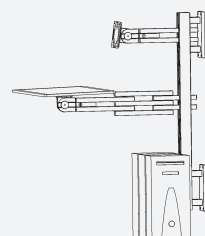

## Linjé complete wall solution with CPU holder and keyboard shelf

606600		silver	627,00
--------	--	--------	--------

Content: Post 700 mm, post 400 mm, threaded pin, mini arm\* for the screen, long arm\*, wooden keyboard shelf, Linjé CPU holder and 2 wall mounts.

Mounting: Recommended height from floor to post, 55 cm.

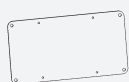

## VESA plate

610700	200x100 mm	silver	22,00
--------	------------	--------	-------

Facts: Adapter VESA attachment plate for 200x100 mm.

Fits all arms. Most suitable for 23 and 26 inch screens.

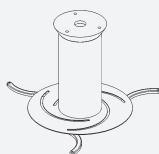

## Projector holder Universal

610521	Ceiling mount for projector	silver	70,00
--------	-----------------------------	--------	-------

Facts: Suits most projectors. Adjustable height 80-170 mm.

Tilt angle 15°. Max. weight 10 kg.

\* All arms include VESA attachment standard for both monitor clamp 75 and 100. Max. weight 12 kg.



Posts and arms are made from **solid** homogeneous anodized aluminium. The attachments are casted in aluminium. Most of the products of the Linjé concept are also available in **chrome, black and red**, price supplement 30%. Add following ref. to Art.No: black = "-2", chrome = "-5", red = "-12".



Please look at the possible combinations on page 7.

# PRODUCT INFORMATION

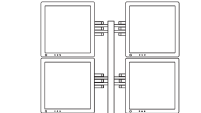
Art.No.                      Size/Description                      Colour                      Price €

	<b>1</b>	<b>Linjé Twin Desk mount complete</b> 603651                      2 pcs x 670 mm                      silver <b>444,00</b> Content: Post 400 mm, Twin arm*, desk mount.
		<b>Wireless keyboard</b> <b>Logitech DiNovo Cordless Desktop - for laptop</b> 122055 <b>Contact us for price</b>

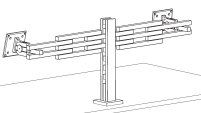
	<b>2</b>	<b>Linjé Double Twin (for four screens)</b> 603670                      Desk clamp L. 4x670 mm                      silver <b>866,00</b> 603671                      Desk mount L. 4x670 mm                      silver <b>866,00</b> Content: Post 700 mm, 4 arms*, mount/clamp.
		<b>Wireless keyboard</b> <b>Logitech DiNovo Cordless Desktop - for laptop</b> 122055 <b>Contact us for price</b>

	<b>3</b>	<b>Linjé Twin Desk mount complete</b> 603651                      2 pcs x 670 mm                      silver <b>444,00</b> Content: Post 400 mm, Twin arm*, desk clamp.
		<b>Wireless keyboard</b> <b>Logitech DiNovo Cordless Desktop - for laptop</b> 122055 <b>Contact us for price</b>

## Additional packages Twin:

	<b>Linjé Twin Desk clamp complete</b> 603601                      2 pcs x 670 mm                      silver <b>444,00</b> Content: Post 400 mm, Twin arm*, desk clamp.
--	---

\* All arms include VESA attachment standard for both monitor clamp 75 and 100. Max. weight 12 kg.

Posts and arms are made from **solid** homogeneous anodized aluminium. The attachments are casted in aluminium. Most of the products of the Linjé concept are also available in **chrome, black and red**, price supplement 30%. Add following ref. to Art.No: black = "-2", chrome = "-5", red = "-12".

Please look at the possible combinations on page 7.

# PRODUCT INFORMATION

	Art.No.	Size/Description	Colour	Price €
	<b>Linjé Post</b>			
	66620	L. 200 mm	silver	<b>70,00</b>
	66640	L. 400 mm	silver	<b>85,00</b>
	66670	L. 700 mm	silver	<b>167,00</b>
Content: <b>Solid</b> homogenous anodized aluminium.				
	<b>Linjé Arm</b>			
	66100	Mini arm L. 315 mm	silver	<b>144,00</b>
	66200	Short arm L. 540 mm	silver	<b>178,00</b>
	66300	Long arm L. 670 mm	silver	<b>189,00</b>
Content: Arm*, in <b>solid</b> homogenous anodized aluminium.				
	<b>Linjé Twin Arm</b>			
	66330	2 pcs x 670 mm	silver	<b>399,00</b>
Content: 2 long arms*, in <b>solid</b> homogenous anodized aluminium inkl. VESA-attachment 75 and 100 mm. Max. weight 12 kg/arm.				
	<b>VESA-plate</b>			
	610700	200x100 mm	silver	<b>22,00</b>
Facts: Adapter VESA attachment plate for 200x100 mm. Fits all arms. Most suitable for 23 and 26 inch screens.				
	<b>Linjé Desk clamp</b>			
	66001	100x100 mm	silver	<b>55,00</b>
Facts: Suits tables with a maximum thickness of 45 mm.				
	<b>Linjé Desk mount</b>			
	66002	100x100 mm	silver	<b>55,00</b>
Ø 80 mm plastic lid 700288 cable grommet is included.				
	<b>Cable grommet Linjé Design</b>			
	700299	Aluminium Ø 79 mm	silver	<b>47,00</b>
	<b>Linjé Wall mount</b>			
	66003	210x80 mm	silver	<b>55,00</b>
	<b>Linjé Ceiling mount (can be attached under desks)</b>			
	66004	120x120 mm	silver	<b>55,00</b>
For heavier screens, please see p. 5.				
	<b>Linjé DockIT shelf</b>			
	66510	Wood 410x410 mm	silver	<b>95,00</b>
	66515	Plexiglass 410x410 mm	smoked	<b>148,00</b>
Facts: Shelf made of silver-coloured wood or from smoke-coloured plexiglass. Incl. rubber mat and 2 adjustable stops for the laptop.				
	<b>Linjé Keyboard shelf</b>			
	66580	Wood 680x330 mm	silver	<b>106,00</b>
	66585	Plexiglass 680x330 mm	smoked	<b>170,00</b>
Facts: Shelf made of silver-coloured wood or from smoke-coloured plexiglass. Incl. rubber mat.				
	<b>Linjé CPU holder</b>			
	66700		silver	<b>78,00</b>
Content: CPU shelf made from aluminium, 2 straps.				
	<b>Linjé Cable holder</b>			
	608050	L. 500 mm	silver	<b>49,00</b>
	608100	L. 1000 mm	silver	<b>67,00</b>
	608150	L. 1500 mm	silver	<b>78,00</b>

# PRODUCT INFORMATION

Art.No.	Size/Description	Colour	Price €
---------	------------------	--------	---------

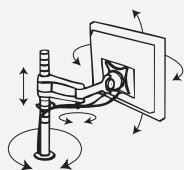

## Wishbone

600100	Desk clamp	silver	352,00
600200	Wall mount	silver	352,00
600300	Desk mount*	silver	352,00
600320	Cable grommet Design	silver	352,00

Contents: Mount, post and arm.

Facts: Suits most of the flat screens on the market, VESA standard for both monitor clamp 75 and 100. Made from casted aluminium. Adjustable in all directions.

Wishbone Quick release is now included in the solution above. Quick release implies that you shift the screen from lying to upright with a flick of a switch. Max. weight 10 kg/arm.

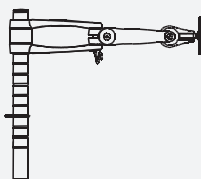

## Wishbone Rotation

620100	Desk clamp	silver	458,00
620200	Wall mount	silver	458,00
620300	Desk mount*	silver	458,00
61136	Toolbar attachment	silver	409,00

Facts: Suits most of the flat screens on the market, VESA standard for both monitor clamp 75 and 100. Made from casted aluminium. Adjustable in all directions. Max. weight 10 kg/arm.

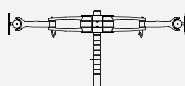

## Wishbone back to back arm

600110	Desk clamp	silver	629,00
600310	Desk mount*	silver	629,00

Content: Double arm incl. VESA attachment 75 and 100.

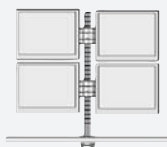

## Wishbone back to back for 4 screens

600350			1118,00
--------	--	--	---------

Content: Desk mount\* with 700 mm post and 2 pcs back to back arms. Incl. VESA attachment 75 and 100. Max. weight 10 kg/arm.

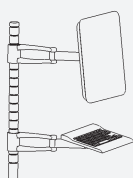

## Wishbone wall assembly with 700 mm post + keyboard tray/mouse plate incl. arm

600400			799,00
--------	--	--	--------



## Wishbone wall assembly with CPU-holder

600450		Contact us for price	
--------	--	----------------------	--

Wishbone package (600400), extra wall mount (61154), extension post 400 mm (61127), CPU-holder (61150).

\*Ø 80 mm plastic lid 700288 cable grommet is included.

# PRODUCT INFORMATION

Art.No.	Size/Description	Colour	Price €
---------	------------------	--------	---------

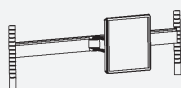

## Wishbone Toolbar

630100-1	1000 mm Desk clamp	silver	<b>325,00</b>
630100-2	1200 mm Desk clamp	silver	<b>327,00</b>
630100-3	1600 mm Desk clamp	silver	<b>346,00</b>
630100-4	1800 mm Desk clamp	silver	<b>353,00</b>
630300-1	1000 mm Desk mount*	silver	<b>347,00</b>
630300-2	1200 mm Desk mount*	silver	<b>349,00</b>
630300-3	1600 mm Desk mount*	silver	<b>368,00</b>
630300-4	1800 mm Desk mount*	silver	<b>375,00</b>

Content: Rail with attachments.

\*Ø 80 mm plastic lid 700288 cable grommet is included.

## Toolbar arm

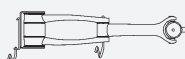

61133	Standard arm	L. 463mm	silver	<b>317,00</b>
-------	--------------	----------	--------	---------------

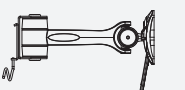

61134	Fore arm	L. 295mm	silver	<b>280,00</b>
-------	----------	----------	--------	---------------



61135	C-post arm	L. 162mm	silver	<b>246,00</b>
-------	------------	----------	--------	---------------



61136	Rotation arm	L. 466mm	silver	<b>409,00</b>
-------	--------------	----------	--------	---------------

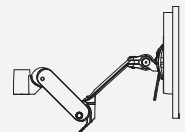

61116	Giselle gas arm	L. 520mm	silver	<b>409,00</b>
-------	-----------------	----------	--------	---------------

Weight span for Giselle is 2-7 kg.

Content: Complete arm to attach to the Toolbar rail.  
Incl. VESA attachment 75 and 100.









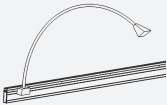

## Setupit storage container A4 for the Toolbar

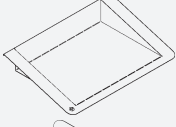
610040	complete incl. attachment	black	<b>35,00</b>
610041	complete incl. attachment	silver	<b>35,00</b>
610042	complete incl. attachment	white	<b>35,00</b>

For more Toolbar fittings, please see p. 10.

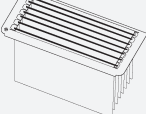
# PRODUCT INFORMATION

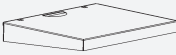
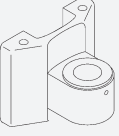
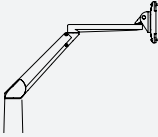
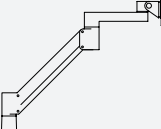





	Art.No.	Size/Description	Colour	Price €
<b>Toolbar fittings</b>				
	672000	LED lamp L. 740 mm Attachable to Toolbar and Freewall. Current 230-240V/1W.	satinkrom	<b>164,00</b>
	61166	CD shelf L: 170 H: 70 D: 140	silver	<b>21,00</b>
	61167	Supplementary shelf L: 405 H: 70 D: 140	silver	<b>30,00</b>
	61168	Memo magnetic board L: 250 H: 250	silver	<b>23,00</b>
	61169	Pencil holder L: 75 H: 75 D: 75	silver	<b>19,00</b>
	61170	Flower tube L: 65	silver	<b>17,00</b>
	61171	File holder L: 470 H: 220 D: 200 5 folders incl.	silver	<b>32,00</b>
	671000	Brochure Collector L: 370 H: 260 D: 130	silver	<b>41,00</b>
	671010	DockIT Freewall small L: 360 H: 50 D: 290	silver	<b>32,00</b>
	671020	DockIT Freewall big L: 460 H: 50 D: 370	silver	<b>35,00</b>
	<b>610502</b>	<b>Toolbar-/Slatwall mount for Evo and Gotessons Free arm</b> Used to attach Evo and Gotessons Free arm to the Toolbar, Freewall or other screenwalls.		<b>80,00</b>
	<b>610410</b>	<b>Evo arm</b> Weight span 2,7-5,9 kg	satin chrome	<b>353,00</b>
	610411	Weight span 4,5-8,2 kg	satin chrome	<b>353,00</b>
	610412	Weight span 4,5-8,2 kg	white	<b>353,00</b>
	610413	Weight span 4,5-8,2 kg	black	<b>353,00</b>
		For more information, please see p. 12.		
	<b>610500</b>	<b>Gotessons Free arm</b> Weight span 4,1-10,9 kg	silver	<b>270,00</b>
		For more information, please see p. 13.		

# PRODUCT INFORMATION

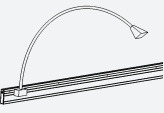
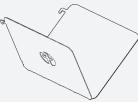
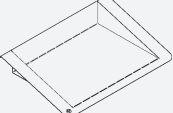
Art.No.	Size/Description	Colour	Price €
 <b>Freewall</b>			
670080	L. 800 mm	silver	<b>31,00</b>
670120	L. 1200 mm	silver	<b>42,00</b>
670150	L. 1500 mm	silver	<b>52,00</b>

Content: Extruded aluminium rail, 2 rail ends and screws incl.  
Available at any disered length of up to 5200 mm.  
Contact us for a quote.

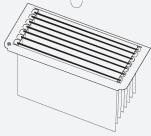
## Freewall fittings

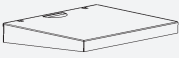
	672000	LED lamp L. 740 mm Attachable to Toolbar and Freewall. Current 230-240V/1W.	satinkrom	<b>164,00</b>
	61166	CD shelf L: 170 H: 70 D: 140	silver	<b>21,00</b>
	61167	Supplementary shelf L: 405 H: 70 D: 140	silver	<b>30,00</b>
	61168	Memo magnetic board L: 250 H: 250	silver	<b>23,00</b>
	61169	Pencil holder L: 75 H: 75 D: 75	silver	<b>19,00</b>
	61170	Flower tube L: 65	silver	<b>17,00</b>
	61171	File holder L: 470 H: 220 D: 200 5 folders incl.	silver	<b>32,00</b>
	671000	Brochure Collector L: 370 H: 260 D: 130	silver	<b>41,00</b>
	671010	DockIT Freewall small L: 360 H: 50 D: 290	silver	<b>32,00</b>
	671020	DockIT Freewall big L: 460 H: 50 D: 370	silver	<b>35,00</b>

## Toolbar-/Slatwall mount for Evo and Gotessons Free arm

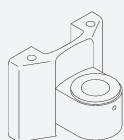

610502 **80,00**

Used to attach Evo and Gotessons Free arm to the  
Toolbar, Freewall or other screenwalls.

## Evo arm

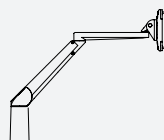

610410	Weight span 2,7-5,9 kg	satinkrom	<b>353,00</b>
610411	Weight span 4,5-8,2 kg	satinkrom	<b>353,00</b>
610412	Weight span 4,5-8,2 kg	white	<b>353,00</b>
610413	Weight span 4,5-8,2 kg	black	<b>353,00</b>

For more information, please see p. 12.

## Gotessons Free arm

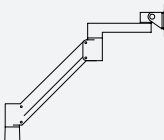

610500 Weight span 4,1-10,9 kg silver **270,00**

For more information, please see p. 13.

# PRODUCT INFORMATION

Art.No.	Size/Description	Colour	Price €
---------	------------------	--------	---------

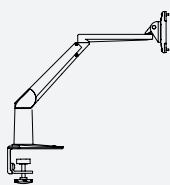

## Evo arm

610410	Weight span 2,7-5,9 kg	satin chrome	<b>353,00</b>
610411	Weight span 4,5-8,2 kg	satin chrome	<b>353,00</b>
610412	Weight span 4,5-8,2 kg	white	<b>353,00</b>
610413	Weight span 4,5-8,2 kg	black	<b>353,00</b>

Available in other colours with an additional cost of 700 Euro (4-5 weeks delivery).

Facts: Gas arm, adjustable in all positions.  
Rotation 360°, monitor tilt 185°. Quick release function. Incl. VESA attachment 75 and 100.

The EVO arm can be mounted in three different ways:

- with desk clamp
- with desk mount 80 mm
- with no bottom plate. The arm is to be assembled through a 10 mm hole in the table top.

Heavier load bearing arms are available. For more information, please see [www.gotessons.se](http://www.gotessons.se)

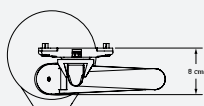

TOP VIEW  
Arm folded

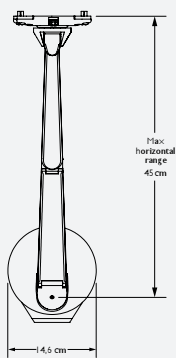

TOP VIEW  
Horizontal Range

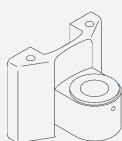

## Toolbar-/Slatwall mount for Evo and Gotessons Free arm

610502

**80,00**

Used to attach Evo and Gotessons Free arm to the Toolbar, Freewall or other screenwalls.

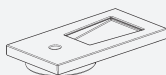

## Cable grommets Design for Evo and Gotessons Free arm

700297-1	Aluminium Ø 79 mm	white	<b>47,00</b>
700297-2	Aluminium Ø 79 mm	black	<b>47,00</b>
700297-3	Aluminium Ø 79 mm	silver	<b>47,00</b>

(Silver suits Evo satin chrome.)

# PRODUCT INFORMATION

Art.No.	Size/Description	Colour	Price €
---------	------------------	--------	---------

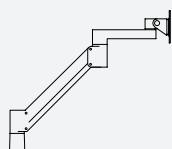

## Gotessons Free arm

610500	Weight span 4,1-10,9 kg	silver	<b>270,00</b>
--------	-------------------------	--------	---------------

Facts: Incl. arm and six mounting options as seen below.  
Incl. VESA attachment 75 and 100.

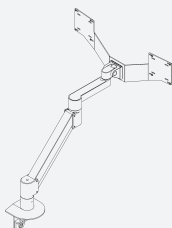

## Gotessons Free arm Double

610503	Weight span 4,1-10,9 kg	silver	<b>375,00</b>
--------	-------------------------	--------	---------------

For two screens. Max. width/screen 45 cm.  
Fakta: Incl. arm and six mounting options as seen below.  
Incl. VESA attachment 75 and 100.

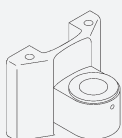
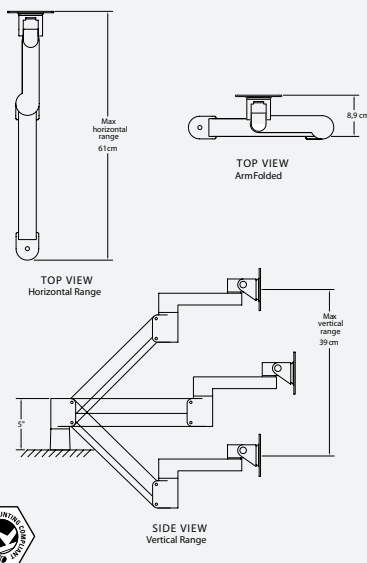
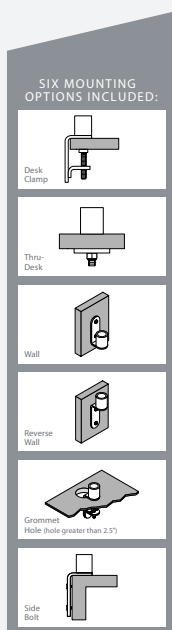

## Toolbar-/Slatwall mount for Evo and Gotessons Free arm

610502			<b>80,00</b>
--------	--	--	--------------

Used to attach Evo and Gotessons Free arm to the Toolbar, Freewall or other screenwalls.

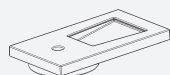

## Cable grommet Design for Evo and Gotessons Free arm

700297-3	Aluminium Ø 79 mm	silver	<b>47,00</b>
----------	-------------------	--------	--------------

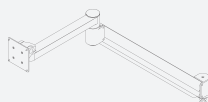

## Gotessons Long reach arm

610420	Long arm, weight span 3-13 kg		<b>700,00</b>
610421	Wall mount		<b>76,00</b>
610422	Desk mount		<b>125,00</b>

Facts: The arm is 106 cm stretched and comes with VESA attachment 75 and 100 mm.

# PRODUCT INFORMATION

Art.No.	Size/Description	Colour	Price €
---------	------------------	--------	---------

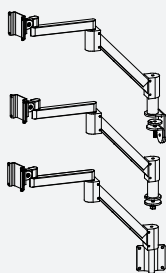

## Anyway

650010	Multi desk clamp	silver	412,00
650011	Desk mount	silver	412,00
650012	Wall mount	silver	412,00

Facts: Anyway gas arm, high move ability and flexibility.  
Incl. VESA attachment 75 and 100.  
Weight span 2-8 kg.

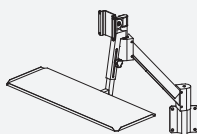

## Anyway wall solution

650022		silver	576,00
--------	--	--------	--------

Facts: Height adjustable arm with keyboard shelf.  
Adjustable in height 40 cm. Incl. VESA attachment  
75 and 100. Weight span 3-11 kg.

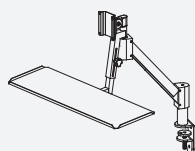

## Anyway multi desk clamp

650020		silver	576,00
--------	--	--------	--------

Facts: Height adjustable arm with keyboard shelf.  
Adjustable in height 40 cm. Suits tables with  
maximum thickness of 100 mm. Can also be  
assembled on the wall. Incl. VESA attachment  
75 and 100. Weight span 3-11 kg.

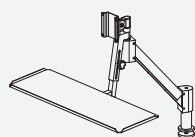

## Anyway desk solution

650021		silver	576,00
--------	--	--------	--------

Facts: Height adjustable arm with keyboard shelf.  
Adjustable in height 40 cm. Incl. VESA attachment  
75 and 100. Weight span 3-11 kg.

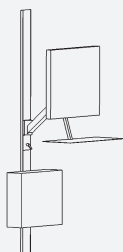

## Anyway walltracX complete pack

650100		silver	<b>Contact us for price</b>
--------	--	--------	-----------------------------

Facts: Aluminium rail 150 cm with integrated plastic  
cable channel. Adjustable CPU holder and gas  
arm with keyboard shelf.

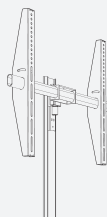

## Anyway walltracX plasma

650110		silver	329,00
--------	--	--------	--------

Facts: For 32-42 inch screens, adjustable. Attache to  
aluminium rail 150 cm with integrated plastic  
cable channel. Max. weight 45 kg.

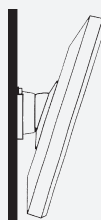

## Wall-IT

610300		black	94,00
--------	--	-------	-------

Facts: Movable wall mount, with the possibility to  
lock with padlock.

## Pad lock for Wall-IT

830010	Equal lock		9,00
830011	Unequal		9,00

# PRODUCT INFORMATION

Art.No.	Size/Description	Colour	Price €
---------	------------------	--------	---------

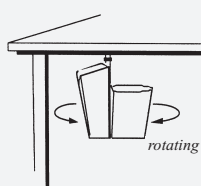

## Recycling station SetUpit

610070	L.250 W.365 H.350	black	<b>70,00</b>
610071	L.250 W.365 H.350	silver grey	<b>70,00</b>
610072	L.250 W.365 H.350	white	<b>70,00</b>
610070-5	L.250 W.365 H.350	black/chrome	<b>91,00</b>
610570	with runner	black	<b>94,00</b>
610571	with runner	silver grey	<b>94,00</b>
610572	with runner	white	<b>94,00</b>
610570-5	with runner	black/chrome	<b>122,00</b>

Content: Complete with rotating holder, suits all desks.

Includes 1 plastic container for paper and 1 for other materials.

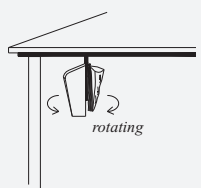

## Recycling SetUpit with Sopi plastic bags

610080	L.250 W.200 H.350	black	<b>70,00</b>
610081	L.250 W.200 H.350	silver grey	<b>70,00</b>
610082	L.250 W.200 H.350	white	<b>70,00</b>
610080-5	L.250 W.200 H.350	black/chrome	<b>91,00</b>
610580	with runner	black	<b>94,00</b>
610581	with runner	silver grey	<b>94,00</b>
610582	with runner	white	<b>94,00</b>
610580-5	with runner	black/chrome	<b>122,00</b>

Content: Complete with rotating holder, suits all

desks. Includes 1 plastic container for paper and 1 holder for Sopi bags.

Setupit can also be made in more colours. Please contact us for more information about quantities, delivery time and price.

### ACCESSORIES:

#### Plastic bags for the small container

610252	Rolls/250 units		<b>5,00</b>
--------	-----------------	--	-------------

### ACCESSORIES:

#### Sopi plastic bags

610262	25 units	silver	<b>4,00</b>
--------	----------	--------	-------------

# PRODUCT INFORMATION

Art.No.                      Size/Description                      Colour                      Price €

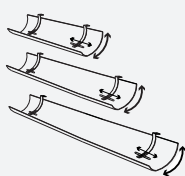

## Cable holder HalfPipe

740049	L.490 W.170 D.80	silver	32,00
740079	L.790 W.170 D.80	silver	36,00
740115	L.1150 W.170 D.80	silver	46,00
740150	L.1500 W.170 D.80	silver	62,00
740170	L.1700 W.170 D.80	silver	66,00

Regarding special dimensions, please ask for quotation.  
Colour options with an additional 10% price increase.

## Cable holder HalfPipe complete

745049	L.490 W.170 D.80	silver	97,00
745079	L.790 W.170 D.80	silver	102,00
745115	L.1150 W.170 D.80	silver	112,00
745150	L.1500 W.170 D.80	silver	129,00
745170	L.1700 W.170 D.80	silver	134,00

Content: 1 cable holder HalfPipe with 2 mounting ladders, 2 plastic pipe ends, 6-way junction box (3 m), 1 network cable Cat.6 (5 m), 1 RJ12 phone cable (5 m), 1 G-clip. All cables are assembled in the Cable Collector Ø 22 (see picture).

## Complete set

700900	Complete network/electricity solution	68,00
Content: 6-way junction box (3 m), 1 network cable (5 m), 1 RJ12 phone cable (5 m), 1 G-clip. All cables are assembled in the Cable Collector Ø 22.		
700930	Separating computer electricity and ordinary electricity	83,00
Content: As above + 3-way junction box.		
700910	The same as 700900 but with 10 m cables	155,00



## COMPLETION:

### Halfpipe plastic end

740020	black	5,75
740020-1	white	5,75
740020-3	silver	5,75

Facts: Injection-moulded innovation made from plastic for optimum design and suitable for Halfpipe complete set/cable collector, shuts off the view and keeps the cables in place.



### Assembly hook for HalfPipe

740010	Makes it easier to assemble HalfPipe	9,00
--------	--------------------------------------	------



## G-Clips

### For mounting cables

700240	5 clips/package Ø 20 mm	black/silver	8,00
700242	5 clips/package Ø 40 mm	black/silver	9,00

Content: 5 clips including screws.

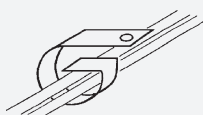

## Junction Box - extension

### Turnable junction box mounted with over voltage protection

700420	4-ways earthed, 3 m cable	white/grey	29,00
700421	6-ways earthed, 3 m cable	white/grey	35,00

### Junction box earthed

700330	3-ways earthed, 1,5 m cable	white	8,00
700333	3-ways earthed, 3 m cable	white	10,00
700400	3-ways earthed, 5 m cable	black	12,00
694500	6-ways earthed, 3 m cable	white	12,00
694550	6-ways earthed, 5 m cable	white	14,00

### Extension earthed

700600	L. 6 m	white	12,00
701000	L. 10 m	white	18,00

### Mouse/Keyboard PS/2

700555	L. 1,8 m		6,00
--------	----------	--	------

### Screen cable

700550	L. 2 m		18,00
700566	L. 5 m		23,00

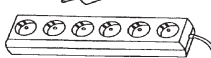
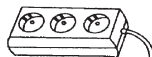
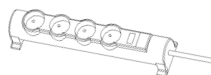

All extensions are compatible to most countries in mainland Europe. Please check with us before placing an order. For more information, see our web-site.

# What is the naked truth

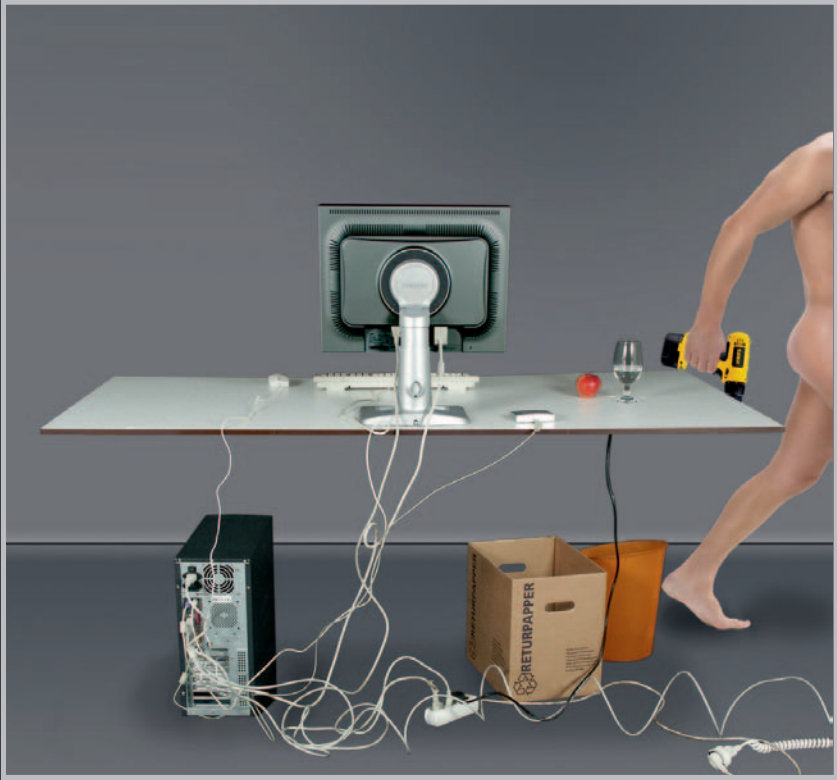

Extreme office  
Can YOU spot

We find it quite simple, five Gotess

**Experience t**  
*to comfort*

“Work environme

---

Since 2001 the Swedish “work environment law  
systematically look at all the areas and aspect  
discussing ways to improve the health and

Arbetsmiljöverket, AF

# What about your office?



What can we make over...

What is the difference?

Why do some products make the difference!

**the elevation**

*and class.*

Work Environment Act - Sweden

The "Work Environment Act" has been implemented so that all companies assess the risks of their work environment, analysing and evaluating the health and safety of staff and minimising injuries.

FS 2001- paragraph 8

# PRODUCT INFORMATION

Art.No.                      Size/Description                      Colour                      Price €

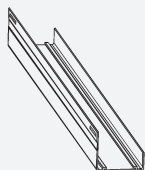

## Linjé Cable holder

608050	L. 500 mm			silver	49,00
608050-5	L. 500 mm			chrome	64,00
608100	L. 1000 mm			silver	67,00
608100-5	L. 1000 mm			chrome	87,00
608150	L. 1500 mm			silver	78,00
608150-5	L. 1500 mm			chrome	101,00

Facts: Designed holder made from aluminium. Fastened with 2 adjustable mounting ladders included. 2 rail ends enclosed.

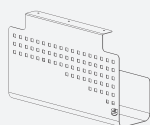

## Cable holder Volume 47

720047	L. 470	W. 135	D. 228	silver	28,00
--------	--------	--------	--------	--------	-------

Facts: Cable holder made from sheet-metal to be used for large amount of cables. Easy to assemble even small areas.



## Cable holder Quick

687548-2	L.480	W.120	D.80	black	16,00
687548-3	L.480	W.120	D.80	silver	16,00
687573-2	L.730	W.120	D.80	black	17,00
687573-3	L.730	W.120	D.80	silver	17,00

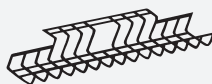

## Cable holder G-49 and G-79

621080-2	L.490	W.105	D.85	black	13,00
621080-3	L.490	W.105	D.85	silver	13,00
621081-2	L.790	W.105	D.85	black	20,00
621081-3	L.790	W.105	D.85	silver	20,00

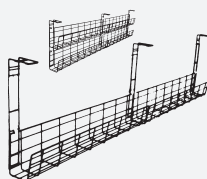

## CableCare Cable holder value pack

700150-2	L.490	W.100	D.145	black	34,00
700150-3	L.490	W.100	D.145	silver	34,00
700180-2	L.790	W.100	D.145	black	35,00
700180-3	L.790	W.100	D.145	silver	35,00

Content: 2 cable holders, 4 mounting ladders, installation kit.

## SUPPLEMENTS:

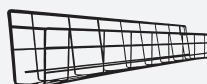

## CableCare Cable holder

700250-2	L.490	W.100	D.145	black	16,00
700250-3	L.490	W.100	D.145	silver	16,00
700280-2	L.790	W.100	D.145	black	18,00
700280-3	L.790	W.100	D.145	silver	18,00



## Mounting ladder

700237	L.360/85		W.45	black/silver	3,50
--------	----------	--	------	--------------	------

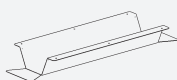

## Cable holder for Conference tables

720000-3	L. 660	W. 124	H. 145	silver	49,00
720000-1	L. 660	W. 124	H. 145	white	54,00

Facts: Cable holder adapted for the Power Box conference, foldable ends for optimum suitability. Made from sheet-metal. Please see page 16 for complete set.

# PRODUCT INFORMATION

Art.No.	Size/Description	Colour	Price €
---------	------------------	--------	---------

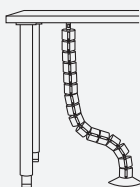

## Cable Collector Ø 60

107550	L.780 (15 sections) Ø 60	black	46,00
107551	L.780 (15 sections) Ø 60	silver	46,00
107554	L.1230 (25 sections) Ø 60	black	59,00
107555	L.1230 (25 sections) Ø 60	silver	59,00
10755	Single section	black/silver	2,00

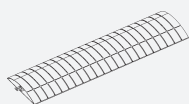

## Cable Collector Cobra

10768-3	W. 90 mm	silver	47,00/m
10769-3	Mount for desk/wall	silver	23,00

Facts: Extendable and stirable plastic collector with two separate channels. 1000 mm closed = 1400 mm open. Delivered closed.

## Tape

731000	Adhesive tape for Cable Collector Cobra		3,50/m
--------	---	--	--------

Please order double length (needs parallel strips).

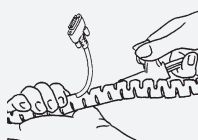

## Cable Collector Ø 22

110050	Inner dimension 22 mm	black	11,00/m
110051	Inner dimension 22 mm	silver	11,00/m
110052	Inner dimension 22 mm	white	11,00/m

## Tool for cable collector Ø 22

110055			8,00
--------	--	--	------

## Cable Collector Ø 22 value pack

110060		silver	26,00
--------	--	--------	-------

Content: 2,5 m cable collector Ø 22 + Tool.

Facts: The flexible tube can simply be opened and closed to add cables very easily. Collects cables between wall socket and desk.

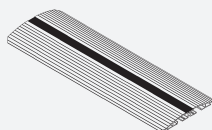

## Floor Cable Collector Aluminium

730080	80 cm	silver	94,00
730120	120 cm	silver	117,00
730160	160 cm	silver	156,00
730200	200 cm	silver	188,00
730300	300 cm	silver	294,00
730350	Straight or angle cut		22,00

Facts: Floor canal system made from aluminium, screwed or taped to the floor.

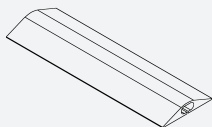

## Floor Cable Collector (environment friendly TPE plastic)

730000		grey	26,00/m
--------	--	------	---------

Price/metre, easy to cut.

## Tape

731000	Adhesive tape for floor cable collectors		3,50/m
--------	--	--	--------

Please, order double length (needs parallel strips).



## Cable through plastic

700288	Ø 79 mm	silver/black/white	3,00
--------	---------	--------------------	------



## Cable through aluminium oval

700290	Ø 80 mm	silver	35,00
--------	---------	--------	-------



## Cable through with brush

700295	Ø 79 mm	silver	9,00
700295-2	Ø 79 mm	black	9,00



## Cable through chrome plastic

700291	Ø 79 mm	chrome	7,00
--------	---------	--------	------



## Cable through zink

700293	Ø 63 mm	matt chrome	10,00
700294	Ø 63 mm	chrome	10,00

## Circular saw for 700288+700295+700291

699300	Ø 79 mm		59,00
--------	---------	--	-------

## Circular saw for 700290

699400	Ø 80 mm		70,00
--------	---------	--	-------

## Circular saw 700293+700294

699200	Ø 64 mm		59,00
--------	---------	--	-------

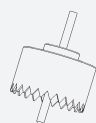

# PRODUCT INFORMATION

Art.No.	Size/Description	Colour	Price €
---------	------------------	--------	---------

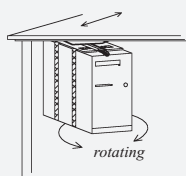

## Swingit CPU holder

871010	Tower/desktop model	silver	93,00
871020	Swingit + Interior Screen	silver	123,00
871040	Stop strip (for shorter gliding function, adjustable)	silver	6,00

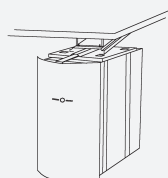

## Interior Screen for Swingit

870130	W.245 H.420 D.75	silver	35,00
--------	------------------	--------	-------

Content: 1 aluminium adjustable sheet, adjustable vertically and sideways, 1 pc of mounting attachment, mounting kit.

## Other products included in The Runner Concept

**1**

### Runner

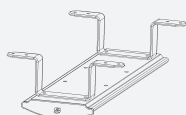

871000		silver	24,00
--------	--	--------	-------

Push/pull and rotating function for the products below, height distances included.

**2**

### Swingit CPU holder

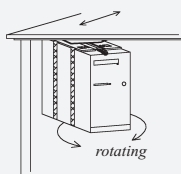

871005	Without runner	silver	69,00
871010	Complete with runner	silver	93,00

Suits both tower and desk model, centered stability with unique after-tension function.

**3**

### Anyway CPU holder

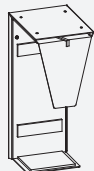

650000	Tower model	silver	82,00
650007	Tower model with runner	silver	112,00

Facts: Suits tower model, width 60-230 mm, height 250-550 mm.

**4**

### CPU holder Stand

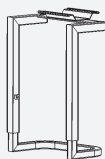

877000	Without runner	silver	69,00
877010	With runner	silver	93,00

Content: Shelf and strap.

**5**

### Recycling station SetUpit

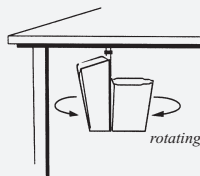

610071	Without runner	silvergrey	70,00
610571	Complete with runner	silvergrey	94,00

Rotating recycling station, which takes little space. Design patented.

SetUpit is also available in more colours, please see page 15.

**6**

### DockIT design



551000	inside 370x370	silver	117,00
551010	incl. rubber mat	silver	135,00

### Complete with runner



551001	inside 370x370	silver	141,00
551011	incl. rubber mat	silver	158,00

Facts: Bended steel tube with shelf made from anodized aluminium.

# PRODUCT INFORMATION

Art.No.	Size/Description	Colour	Price €
---------	------------------	--------	---------

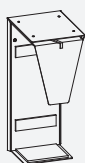

## Anyway CPU-holder

650000	Tower model without runner	silver	82,00
650000-1	Tower model without runner	white	94,00
650007	Tower model with runner	silver	112,00
650007-1	Tower model with runner	white	122,00

Facts: Suits tower model, W. 60-230 mm, H. 250-550 mm.

## Anyway CPU holder mini

650002	Tower model without runner	silver	94,00
--------	----------------------------	--------	-------

Facts: Suits small CPU-units and thin clients. Does not suit the Runner Concept. W. 30-100 mm. H. 175-310 mm.

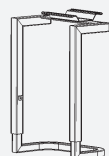

## CPU holder Stand

877000	Without runner	silver	69,00
877010	With runner	silver	93,00

Content: Shelf and strap.

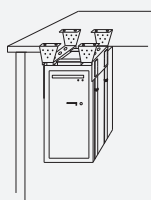

## ALI CPU holder value pack

870433	Tower model/desktop model	silver	55,00
--------	---------------------------	--------	-------

incl. distances

Content: 4 distances, 2 aluminium profiles, 2 straps (L.1700 mm), mounting kit.



## ALI CPU holder

870430	Tower model/desktop model	silver	46,00
--------	---------------------------	--------	-------

excl. distances

Content: 2 aluminium profiles, 2 straps (L.1700 mm), mounting kit.



## SUPPLEMENTS:

### Height distances for Ali

870431	H.70 mm	silver	14,00
--------	---------	--------	-------

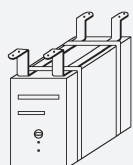

## CPU holder 1

872300	Tower model/desktop model	silver	39,00
872310	Tower model for Barebone and Mac (G3/G4)	silver	39,00

Simple model easy to assemble.

Content: 2 flat wire profiles. 2 straps (L.1700 mm), mounting kit.

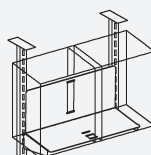

## CPU stand with shelf

Suitable for gable placement

873000	W.250 H.495 D.400	silver	61,00
--------	-------------------	--------	-------

Content: Computer shelf, strap, DGU-stand 495 mm (alt. 595 mm).



## CPU trolley

870000	160-260 mm	grey	24,00
--------	------------	------	-------

Content: Made from plastic, width adjustable, suitable for offices with limited space underneath the desk.

# PRODUCT INFORMATION

Art.No.	Size/Description	Colour	Price €
---------	------------------	--------	---------



## DockIT design

551000	inside 370x370	silver	117,00
551010	incl. rubber mat	silver	135,00



## DockIT design incl. runner

551001	inside 370x370	silver	141,00
551011	incl. rubber mat	silver	158,00

Facts: Bended steel tube with shelf made from anodized aluminium.

## DockIT without runner

531011	D. 400 W. 350 H. 140	silver	75,00
541011	D. 400 W. 440 H. 140	silver	75,00

## DockIT incl. runner

531010	D. 400 W. 350 H. 140	silver	99,00
541010	D. 400 W. 440 H. 140	silver	99,00

Push/pull and rotating, hanging underneath the desk for laptop/docking station.

## DockIT Flexible over board

552100	without rubber mat	silver	311,00
552110	with rubber mat	silver	329,00

Content: Gotessons Freearm, shelf in anodized aluminium. Incl. six mounting options. This solutions suits above board and wall mounting.

## DockIT Flexible under board

552000	without rubber mat	silver	352,00
552010	with rubber mat	silver	370,00

Content: Gotessons Freearm, post 305 mm, shelf in anodized aluminium.

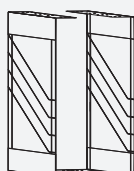

## BoxUp – tower model/desktop model

881324-2	W.130/230 H.485 D.465	black	82,00
881324-3	W.130/230 H.485 D.465	silver	82,00
881321-2	W.485 H.120/215 D.465	black	82,00
881321-3	W.485 H.120/215 D.465	silver	82,00

Content: BoxUp without lock, vibration/noise absorbing polyethylene mat, self-adhesive tape, installation kit.



## BoxUp – tower model/desktop model with lock

881323-2	W.130/230 H.485 D.465	black	98,00
881323-3	W.130/230 H.485 D.465	silver	98,00
881222-2	W.485 H.120/215 D.465	black	98,00
881222-3	W.485 H.120/215 D.465	silver	98,00

Content: BoxUp with lock, pad lock with braces, vibration/noise polyethylene mat, self-adhesive tape, installation kit.

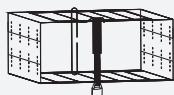

## SUPPLEMENTS:

### BoxUp lock/Brace package

881000			27,00
--------	--	--	-------

Facts: Completion for BoxUp without lock.

### Height distances for BoxUp

850008	H.60 mm	black/silver	24,00
--------	---------	--------------	-------

Content: 4 cube formed distances, 60x60 mm.

# PRODUCT INFORMATION

Art.No.	Size/Description	Colour	Price €
---------	------------------	--------	---------

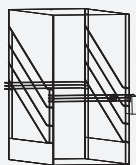

## G-box – tower model

845100	W.130 H.390 D.380	black/silver	<b>223,00</b>
845130	W.130 H.480 D.500	black/silver	<b>223,00</b>
845180	W.180 H.480 D.500	black/silver	<b>223,00</b>
845220	W.220 H.480 D.500	black/silver	<b>223,00</b>
845260	W.260 H.480 D.500	black/silver	<b>223,00</b>

## G-box – cube model

845225	W.220 H.240 D.320	black/silver	<b>223,00</b>
--------	-------------------	--------------	---------------



## G-box – desktop model

833100	W.390 H.130 D.380	black/silver	<b>223,00</b>
833131	W.450 H.130 D.500	black/silver	<b>223,00</b>
833181	W.450 H.180 D.500	black/silver	<b>223,00</b>

## G-box for wall mount

846100	W.130 H.390 D.380	black/silver	<b>270,00</b>
846130	W.130 H.480 D.500	black/silver	
846180	W.180 H.480 D.500	black/silver	
846220	W.220 H.480 D.500	black/silver	
846260	W.260 H.480 D.500	black/silver	

Content: Complete G-box with padlock and 2 distances (60x60x490 mm) for wallmount.

## G-box - special

850000	Special dimensions	black/silver	<b>fr. 282,00</b>
--------	--------------------	--------------	-------------------

Please, contact us regarding your requests on the G-boxes for special dimensions.

Content: Hardened brace with a powerful class 2 pad lock, vibration/noise absorbing polyethylene mat, high quality self-adhesive tape, STOP decal, of through screw bolts.

## COMPLETION:

### Height distances for the G-box

850007	H.60 mm	black/silver	<b>29,00</b>
--------	---------	--------------	--------------

Note! Please specify the width of the box.

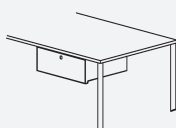

## Laptop box

866000	W. 380 H. 100 D. 420	silver	<b>153,00</b>
--------	----------------------	--------	---------------

Facts: Anti-theft for laptop with extensible plate.







## COMPLETION:

### Height distances for Laptop box

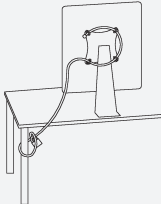
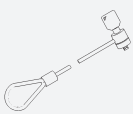
850010	60x60 mm	silver	<b>29,00</b>
--------	----------	--------	--------------

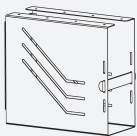
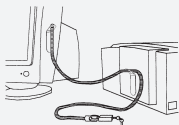
Content: 4 distances, mounting kit with 2 profiles of flat iron to increase stability.

# PRODUCT INFORMATION

	Art.No.	Size/Description	Colour	Price €
	<b>Wirelock with padlock</b>			
	600930	Unequal lock L. 1600 mm		<b>70,00</b>
	600950	Equal lock L. 1600 mm		<b>70,00</b>
	600935	Unequal lock L. 2500 mm		<b>71,00</b>
	600955	Equal lock L. 2500 mm		<b>71,00</b>
	Content: 1 plastic coated steel wire with pad lock. Strengthened lock case, 4 steel cylinders, threaded screws M4 (VESA-standard).			
<hr/>				
	<b>Lapsaver laptop locking</b>			
	600800	L. 1750 mm		<b>82,00</b>
Facts: Cylinder lock with key. Suits most laptops.				
	<b>Laptop Combination lock</b>			
	600850	L. 1850 mm		<b>46,00</b>
Facts: Cylindrical combination lock. Suits most laptops.				
<hr/>				
	<b>Clientbox</b>			
	860100	W. 110 H. 245 D. 310	silver	<b>82,00</b>
	860150	W. 150 H. 300 D. 350	silver	<b>82,00</b>
Facts: Anti-theft for thin clients or small CPU-units.				
<hr/>				
	<b>G-wire value pack</b>			
	830000	L.1600 mm		<b>46,00</b>
	830001	L.2500 mm		<b>47,00</b>
Content: 1 plastic coated wire, strengthened lock case, 2 Götessons fixing plates with tape, 1 pad lock with unequal or equal lock.				
	<b>G-wire</b>			
	830002	L.1600 mm	transparent	<b>22,00</b>
	830003	L.2500 mm	transparent	<b>24,00</b>
	<b>Fixing Plates</b>			
	830006	Angle model	grey	<b>12,00</b>
	<b>Götessons Fixing Plate</b>			
	830007		silver	<b>12,00</b>
	<b>Pad lock</b>			
	830010	Equal lock		<b>9,00</b>
	830011	Unequal		<b>9,00</b>

# PRODUCT INFORMATION



Art.No.	Size/Description	Colour	Price €
<b>Powerport electricity</b>			
694900	3 m cable 2 extensions. Plastic lid in silver.	silver	184,00
694000	3 m cable 3 extensions. Plastic lid in silver.	silver	194,00
694009	3 m cable 2 extensions. Lid of stainless steel.	silver	322,00
694010	3 m cable 3 extensions. Lid of stainless steel.	silver	341,00

## Powerport electricity/network/USB

695000	3 m cable 2 extensions, 3 network conn. Plastic lid in silver.	silver	235,00
695051	3 m cable 3 extensions, 2 network conn., USB. Plastic lid in silver.	silver	470,00
695003	3 m cable 3 extensions, 2 network conn. Lid of stainless steel.	silver	364,00
695052	3 m cable 3 extensions, 2 network conn., USB. Lid of stainless steel.	silver	588,00
695150	3 m cable 4 extensions, 4 network conn. Plastic lid in silver.	silver	352,00

## Powerport light-emitting Diode

694955	3 m cable 3 extensions. Blue light emitting diodes. Lid of stainless steel.	silver	466,00
695900	3 m cable 3 extensions, 2 network conn., blue light emitting diodes. Lid of stainless steel.	silver	482,00

## Powerport multimedia

695301	3 m cable	silver	<b>Contact us for price</b>
695302	5 m cable 2 extensions, 2 network conn., VGA, 3,5 mm mini-jack (computer sound). Plastic lid in silver. All cables included.	silver	
695306	3 m cable	silver	<b>Contact us for price</b>
4 extensions, 4 network conn., VGA, 3,5 mm mini-jack (computer sound). Plastic lid in silver. All cables included.			

## Powerport multimedia light-emitting Diode

695902	5 m cable 2 extensions, 2 network conn., VGA, 3,5 mm mini-jack (computer sound). Blue light emitting diodes. Lid of stainless steel. All cables included.	silver	<b>Contact us for price</b>
--------	---	--------	-----------------------------

## Powerport multimedia chrome

695331	3 m cable	chrome	<b>Contact us for price</b>
2 extensions, 2 network conn., VGA, 3,5 mm mini-jack (computer sound). Lid in chrome. All cables included.			

Facts: Powerport to be inserted in desks or tables, adjustable in height. Earthed extensions (Swedish standard). Network extension Cat.6 female-female. Hole Ø 102 mm. Please notice that the armament always comes in black. The colour above refers to the case. Guarantee 2 years.

All extensions are compatible to most countries in mainland Europe. Please check with us before placing an order. For more information, see our web-site.

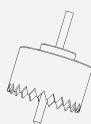

## Circle saw for Powerport

699500	Ø 102 mm		70,00
Complete for use with a drilling machine.			

# PRODUCT INFORMATION

Art.No.	Size/Description	Colour	Price €
---------	------------------	--------	---------

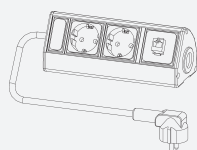

## Powercenter

696000	3 m cable	silver	93,00
	3 extensions		
697000	3 m cable	silver	129,00
	2 extensions, 2 network conn.		

Facts: Extensions for current and network to be assembled on or under desks or tables. Swedish standard.

## Powercenter multimedia

697302	3 m cable	silver	458,00
	1 extensions, 2 network conn., VGA, 3,5 mm mini-jack (computer sound). All cables are included.		
697300	3 m cable	silver	470,00
	2 extensions, 2 network conn., VGA, 3,5 mm mini-jack (computer sound). All cables are included.		
697310	5 m cable	silver	

4 extensions, 4 network conn., VGA, **Contact us for price**  
3,5 mm mini-jack (computer sound). All cables are included.

Facts: Extensions for current and network to be assembled on or under desks. Swedish standard.

## Bracket for assembling Powercenter underneath desks

697100			11,00
--------	--	--	-------

## Desk clamp for Powercenter

697500			33,00
--------	--	--	-------



## Powercenter T-dock

696500	2,5 m cable	silver	184,00
--------	-------------	--------	--------

Facts: 2 extensions, delivered with a separate contact.

Assembled through the desk. A hole Ø 24 mm must be drilled through the table top. Suits desks with maximum thickness of 40 mm.

## Circle saw for T-dock

699100	Ø 24 mm		54,00
--------	---------	--	-------

Complete for use with a drilling machine.

Please notice that the armament always comes in black.  
The colour above refer to the case.

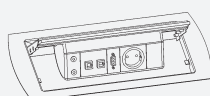

## Power Box with Powercenter

691050	5 m cable	silver	588,00
	1 extension, 2 network conn., VGA, 3,5 mm mini-jack (computer sound). All cables are included.		

Facts: To be built into the desk. Inner dimension (to saw out in the table top) 285x135 mm.



## Power Box extra long

691710	Unarmed	silver	152,00
697300	Powercenter (mounted)	silver	658,00

2 extension, 2 network conn. Cat.6, VGA, mini-jack.

Facts: To be built into the desk. Inner dimension (to saw out in the table top) 395x135 mm.

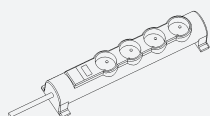

## Turnable extensions, mounted with over voltage protection

700420	4 way earthed, 3 m cable	white/grey	29,00
700421	6 way earthed, 3 m cable	white/grey	35,00

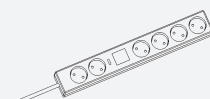

## SavePower

700800	3 m cable	white	46,00
--------	-----------	-------	-------

Facts: Six extensions, the first two have permanent power (you connect the harddrive here). Between these two and the other four, there is a chip that controls active/standby for the harddrive. When the computer is on standby, the power shuts off for the other 4 extensions. Avoids unnecessary electricity consumption!

# PRODUCT INFORMATION

Art.No.	Size/Description	Colour	Price €
---------	------------------	--------	---------



## Power Box Rectangular

691010	Unarmed	silver	93,00
691010-1	Unarmed	white	102,00
691010-5	Unarmed	chrome	121,00

Use the Complete Set together with unarmed Power Box (please, see page 16).

691000	3 extensions, 2 network conn.*	silver	164,00
691000-1	3 extensions, 2 network conn.*	white	181,00
691000-5	3 extensions, 2 network conn.*	chrome	214,00

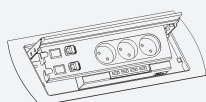

## Power Box USB

691100	3 extensions, 2 network conn.*, 4 USB	silver	212,00
691100-1	3 extensions, 2 network conn.*, 4 USB	white	232,00
691100-5	3 extensions, 2 network conn.*, 4 USB	chrome	275,00

Facts: As above but with 4 USB ports.

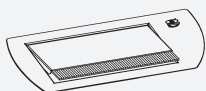

## Power Box G-design

692010	Unarmed	silver	93,00
692010-1	Unarmed	white	102,00

Use the Complete Set together with unarmed Power Box (please, see page 16).

692000	3 extensions, 2 network conn.*	silver	164,00
692000-1	3 extensions, 2 network conn.*	white	181,00

Facts: To be built into the desk. Inner dimension (to saw out in the table top) 285x135 mm. Can easily be completed with VGA, see below.

\*Mounted network connections Cat.6 and earthed extensions.

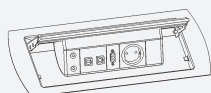

## Power Box with Powercenter

691050	5 m cable	silver	588,00
--------	-----------	--------	--------

1 extension, 2 network conn., VGA, 3,5 mm mini-jack (computer sound). All cables are included.

Facts: To be built into the desk. Inner dimension (to saw out in the table top) 285x135 mm.

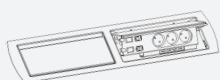

## Power Boxen conference cross opened with Powercenter

691665	5 m cable	silver	776,00
--------	-----------	--------	--------

4 extensions, 4 network conn., 4 USB, permanent VGA conn. 3,5 mm mini-jack. All cables incl.

Facts: To be built into the desk. Inner dimension (to saw out in the table top) 592x135 mm. This model delivers with Powercenter in opening 1 and ordinary armed with USB in opening 2.



## Power Box extra long

691710	Unarmed	silver	152,00
697300	Powercenter complete	silver	658,00

2 extension, 2 network conn. Cat.6, VGA, mini-jack.

Facts: To be built into the desk. Inner dimension (to saw out in the table top) 395x135 mm.

VGA, sound, network cable, switch etc. please see next page.

# PRODUCT INFORMATION

Art.No.	Size/Description	Colour	Price €
---------	------------------	--------	---------

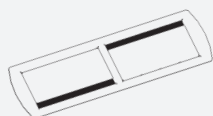

## Power Box conference cross opened

691600	6 extensions, 4 network conn.*	silver	291,00
691600-1	6 extensions, 4 network conn.*	white	320,00
691600-5	6 extensions, 4 network conn.*	chrome	379,00
691610	Unarmed	silver	172,00
691610-1	Unarmed	white	190,00
691610-5	Unarmed	chrome	224,00

## Power Box conference cross opened USB

691660	6 extensions, 4 network conn.*, 8 USB	silver	364,00
691660-1	6 extensions, 4 network conn.*, 8 USB	white	401,00
691660-5	6 extensions, 4 network conn.*, 8 USB	chrome	473,00

Facts: To be built into the desk. Inner dimension (to saw out in the table top) 592x135. Can easily be completed with VGA cable (see below) alt. integrate VGA in Power Box, please see page 26 (Art.No. 691665).

\*Mounted network connections Cat.6 and earthed extensions.

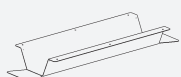
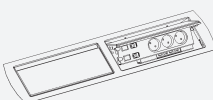

## Cable holder for Conference tables

720000-1	L. 660 W. 124 H. 145	white	54,00
720000-3	L. 660 W. 124 H. 145	silver	49,00

Facts: Cable holder adapted for the Powerbox conference, foldable ends for optimum suitability. Made from sheet-metal.

## COMPLETION:



### Screen cable

700550	L. 2 m	male-female cable extension	18,00
700551	L. 3 m	male-female cable extension	18,00
700584	L. 1 m	male-male	15,00
700578	L. 2 m	male-male	19,00
700566	L. 5 m	male-male	23,00
700577	L. 15 m	male-male	59,00

### Network switch

700580	5 ports, 10/100 Mbps. Exterior dimension: 70x118x27 mm. Can be placed in a cable holder for conference table.	50,00
--------	---	-------

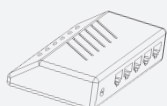

### KVM-switch

700585		129,00
--------	--	--------

Facts: 1 console controls 4 computers, PS/2 complete with all cables for keyboard and mouse.  
Max resolution 1920x1440.  
Can be placed in a cable holder for conference table.

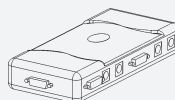

### Plastic clip for cables: VGA, network, sound etc.

700567		2,25
--------	--	------

### Extra network connections

700581	black	11,00
--------	-------	-------

Facts: Network conn. Cat.6 for punched holes. Suits also as an extension of network cables (female-female).

### Cable extension loud speaker

700554	L. 1.8 m	male-female	9,00
700572	L. 5 m	male-female	11,00

### Network Cables STP Cat.6 Shielded

700575	L. 1 m	7,00
700564	L. 3 m	9,00
700559	L. 5 m	9,00
700571	L. 7 m	13,00
700568	L. 10 m	16,00

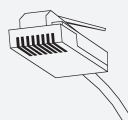

If you have needs for other cables besides our assortment, please let us know.

# PRODUCT INFORMATION

Art.No.	Size/Description	Colour	Price €
---------	------------------	--------	---------



## MakelT Cooler

545700 Size 350x280mm

**70,00**

Facts: Cooling plate with heat absorbing elements. Cooling effect for at least 5 hours. Simply recharges in room temperature (3 hours in 24° and the cooling elements are ready for use).



## MakelTsoft Cooler

545710 Size 350x280mm

**117,00**

Content: Cooling plate mounted in MakelTsoft-cushion.



## MakelTsoft (Suits backpack down side)

545600 Size 350x280 mm

**53,00**

Black fabric filled with styrofoam, antireflection plexiglass.



## MakelTsoft / Commercial

545599 Size 350x280 mm

**Contact us for price**

The same model as above but for commercial use.



## Jellyfish

547000

red

**105,00**

547001

white

**105,00**

547002

yellow

**105,00**

547003

black

**105,00**

Facts: Designed to raise the laptop screen to optimum height. Jellyfish used in conjunction with a separate keyboard, corrects the ergonomic problems associated with laptop use.



## Document rack for Jellyfish

547010

**12,00**

Facts: Rack for Jellyfish in bended acrylic.

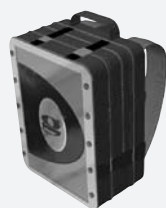

## Backpack

549000

**141,00**

Facts: Backpack for laptop in an ergonomic style. It's designed in strong nylon, aluminium frame, anti-reflection coated Plexiglass with an exchangeable advertising folder on the backside. Spacious computer bag with 3 zipped pockets for all sorts of accessories. Padded computer bag, moulded back with straps, 2 special pockets in front, space for MakelTsoft, combination lock enclosed.



## Backpack with light emitting diodes

548000

**553,00**

Facts: We laser cut your logo into the acrylic to your requests. The logo will be lit up by light emitting diodes in the frame. Rechargeable batteries inside the backpack. As easy to recharge, as a mobile phone. Recharger included. A very effective marketing tool!

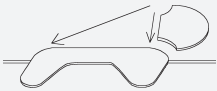
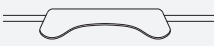
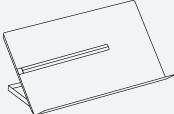
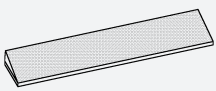
# PRODUCT INFORMATION

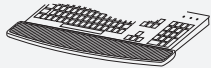
Art.No.	Size/Description	Colour	Price €
	<b>Asymmetrical arm rest + mouse pad Value pack</b> 122020 (122010 + 122011)	black	<b>152,00</b>
	<b>Asymmetrical arm rest</b> 122010 W.480 H.21 D.270	black	<b>141,00</b>
	Facts: Asymmetrical arm rest, filled with cellular polyethylene, covered with antistatic lycra fabric. Removable attachment arm (fits all desks). Bottom plate made from 4 mm sheet-metal.		
	<b>Asymmetrical mouse pad</b> 122011	black	<b>17,00</b>
	Facts: Formed mouse pad made to fit the asymmetrical arm rest above, could be used on both sides (left and right hand). Filled with cellular polyethylene, covered with antistatic lycra fabric.		
	<b>Simple Rest</b> 122006 L.670 W.230 H.20	black	<b>111,00</b>
	Facts: Traditional arm rest. Holders can be adjusted for round tables. Covered with lycra fabric.		
	122007	black	<b>152,00</b>
	ESD design, covered with galon.		
	<b>Document holder</b> 124001 L.375 H.260	grey	<b>67,00</b>
	<b>Wrist Support 2003</b> 121020 L.500 W.105 H.19	black	<b>22,00</b>
	Facts: Wrist support, extra deep, filled with gel.		
	<b>Gel Mouse HC 2040</b> 121002	black	<b>8,00*</b>
	Facts: Drop-shaped mouse pad filled with formed gel, covered with lycra fabric.		
	<b>Gel Keyboard HC 2013</b> 121001 L.495 W.80 H.16	black	<b>12,00*</b>
	Facts: Wrist support filled with gel, covered with lycra fabric.		

\*Now lower price!

# PRODUCT INFORMATION

Art.No.	Size/Description	Colour	Price €
---------	------------------	--------	---------



## RollerMouse

122700	L. 510 W. 90 H. 33	white	
122701	L. 510 W. 90 H. 33	black	
122700-3	L. 510 W. 90 H. 33	silver	

**Contact us for price**

## RollerMouse Pro

122750	L. 510 W. 90 H. 33	white	
122751	L. 510 W. 90 H. 33	black	

With 67% longer trackpoint and more programmable buttons.

**Contact us for price**

Facts: Ergonomical trackpoint/mouse with multifunction.  
Suitable for USB/PS2 with "plug and play" function.



## RollerWave wrist support

122710	L. 510 W. 155 H. 33	white	
122711	L. 510 W. 155 H. 33	black	

**Contact us for price**

Facts: Wrist support in an ergonomical shaped design with extra depth for RollerMouse. Produced in plastic with soft filling and covered with black lycra fabric.

## RollerMouse incl. RollerWave wrist support

122900		white	
122901		black	

**Contact us for price**



## Asymmetrical arm rest

122010	W.480 H.21 D.270	black	<b>141,00</b>
--------	------------------	-------	---------------

Facts: Asymmetrical arm rest, filled with cellular polyethylene, covered with antistatic lycra fabric. Removable attachment arm (fits all desks). Bottom plate made from 4 mm sheet-metal.



## Wireless keyboard

### Logitech DiNovo Cordless Desktop - for laptop

122055			<b>Contact us for price</b>
--------	--	--	-----------------------------

Content: Wireless keyboard and keypad, optical mouse, USB mini receiver.

Facts: A highclassed combination of ergonomics, comfort and flexibility. The wireless technology of Logitech gives you access to cryptical connections between the keyboard, keypad, mouse and the receiving station.

# PRODUCT INFORMATION

Art.No.                      Size/Description                      Colour                      Price €

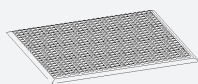

## Bubble

180000                      640x480 mm                      dark grey                      **100,00**  
 Facts: Ergonomic soft mat with massage function.  
 Pvc-free polyurethan.

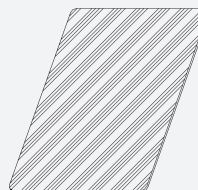

## Floor Protection Standard for plain floors

231810                      1020x1220 mm                      **69,00**  
 231190                      1520x1170 mm                      **78,00**  
 231870                      1980x1220 mm                      **111,00**

## Floor Protection Standard for carpet covered floors

212810                      1020x1220 mm                      **81,00**  
 212190                      1520x1170 mm                      **103,00**  
 212870                      1980x1200 mm                      **123,00**

Facts: Rectangular with rounded corners and sloped edges, transparent made from high quality polyvinyl, thickness 3 mm, delivery of 1 pc in card board packaging, 10 years guarantee.

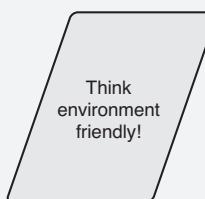

## Floor Protection Standard made from environment friendly Polycarbonate

### For plain floors, 100% recyclable

130710                      900x1200 mm                      **105,00**  
 130730                      1200x1500 mm                      **141,00**  
 130740                      1200x1800 mm                      **176,00**

### For carpet covered floors, 100% recyclable

132710                      1000x1200 mm                      **105,00**  
 132730                      1200x1500 mm                      **141,00**  
 132740                      1200x2000 mm                      **176,00**

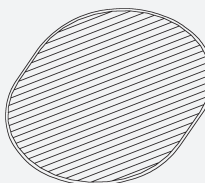

## Static conducting

### Rectangular – for carpet covered floors only

142070                      1500x1200 mm                      **115,00**

## Floor Protection Design oval for plain floors

232770                      1220x1520 mm                      **152,00**

## Floor Protection Design oval for carpet covered floors

233770                      1220x1520 mm                      **152,00**

Facts: Designed with rounded corners and sloped edges, transparent made from high quality polyvinyl, thickness 4 mm, delivery of 1 pc in card board packaging, 10 years guarantee.

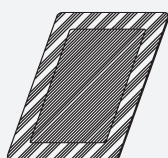

## Combined Floor Protection sit and stand

232010                      910x1220 mm                      **211,00**  
 232020                      1520x1220 mm                      **317,00**

Facts: Combined transparent floor protection/ergonomic mat for desks that can be raised and lowered. Thickness 4 + 9 mm. Suits both plain floors and carpet covered floors.

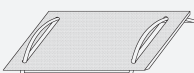

## Foot support

125001                      L.530 W.360 H.125                      black                      **88,00**

Facts: Strong frame made from bended tube, 16 mm wooden plate covered with rubber.